



HAL
open science

Mutations in the Membrane Anchor of Yeast Cytochrome *c1* Compensate for the Absence of Oxa1p and Generate Carbonate-Extractable Forms of Cytochrome *c1*

Patrice Hamel, Claire Lemaire, Nathalie Bonnefoy, Paule Brivet-Chevillotte,
Geneviève Dujardin

► **To cite this version:**

Patrice Hamel, Claire Lemaire, Nathalie Bonnefoy, Paule Brivet-Chevillotte, Geneviève Dujardin. Mutations in the Membrane Anchor of Yeast Cytochrome *c1* Compensate for the Absence of Oxa1p and Generate Carbonate-Extractable Forms of Cytochrome *c1*. *Genetics*, 1998, 150, pp.601-611. cea-02473320

HAL Id: cea-02473320

<https://hal-cea.archives-ouvertes.fr/cea-02473320>

Submitted on 10 Feb 2020

HAL is a multi-disciplinary open access archive for the deposit and dissemination of scientific research documents, whether they are published or not. The documents may come from teaching and research institutions in France or abroad, or from public or private research centers.

L'archive ouverte pluridisciplinaire **HAL**, est destinée au dépôt et à la diffusion de documents scientifiques de niveau recherche, publiés ou non, émanant des établissements d'enseignement et de recherche français ou étrangers, des laboratoires publics ou privés.

Mutations in the Membrane Anchor of Yeast Cytochrome *c1* Compensate for the Absence of Oxa1p and Generate Carbonate-Extractable Forms of Cytochrome *c1*

Patrice Hamel,* Claire Lemaire,* Nathalie Bonnefoy,* Paule Brivet-Chevillotte† and Geneviève Dujardin*

*Centre de Génétique Moléculaire du Centre National de la Recherche Scientifique, 91198 Gif-sur-Yvette Cedex, France and †Bioénergétique et Ingénierie des Protéines, Institut de Biologie Structurale et Microbiologie, Centre National de la Recherche Scientifique, 13402 Marseille Cedex 20, France

Manuscript received December 30, 1997

Accepted for publication July 1, 1998

ABSTRACT

Oxa1p is a mitochondrial inner membrane protein that is mainly required for the insertion/assembly of complex IV and ATP synthase and is functionally conserved in yeasts, humans, and plants. We have isolated several independent suppressors that compensate for the absence of Oxa1p. Molecular cloning and sequencing reveal that the suppressor mutations (*CYT1-1* to *-6*) correspond to amino acid substitutions that are all located in the membrane anchor of cytochrome *c1* and decrease the hydrophobicity of this anchor. Cytochrome *c1* is a catalytic subunit of complex III, but the *CYT1-1* mutation does not seem to affect the electron transfer activity. The double-mutant *cyt1-1,164*, which has a drastically reduced electron transfer activity, still retains the suppressor activity. Altogether, these results suggest that the suppressor function of cytochrome *c1* is independent of its electron transfer activity. In addition to the membrane-bound cytochrome *c1*, carbonate-extractable forms accumulate in all the suppressor strains. We propose that these carbonate-extractable forms of cytochrome *c1* are responsible for the suppressor function by preventing the degradation of the respiratory complex subunits that occur in the absence of Oxa1p.

IN mitochondria, five enzymatic complexes located within the inner membrane catalyze the oxidative phosphorylation. The respiratory complexes I–IV transfer the electrons from NADH and succinate to oxygen; the complex V or ATP synthase utilizes the electrochemical gradient of protons generated by the electron flow to produce ATP. Complexes III (coenzyme QH₂-cytochrome *c* reductase), IV (cytochrome *c* oxidase), and V each consist of 10 or more nonidentical subunits encoded by the mitochondrial or the nuclear genomes. The assembly of these oligomeric enzymes is an intricate process that also requires the action of assembly-assisting factors, also called chaperones, which are not intrinsic components of the complexes, but are required for their formation (see Grivell 1995 for review). In addition, a proteolytic system able to rapidly degrade the unassembled subunits that may disturb the organization of the inner membrane has been discovered, two of its components exhibiting both the chaperone and the protease functions (Artl *et al.* 1996; Rep and Grivell 1996b; see Suzuki *et al.* 1997 and references therein).

Oxa1p, one of the assembly-assisting factors, appears particularly interesting because we have shown that its

protein sequence is conserved between prokaryotes and eukaryotes and that it is functionally conserved in yeast, humans, and higher plants (Bonnefoy *et al.* 1994b; Hamel *et al.* 1997). Yeast cells carrying an inactivated *OXA1* gene are respiratory deficient. They display no cytochrome *c* oxidase activity, a block in the export and proteolytic maturation of the mitochondrially encoded subunit Cox2p of cytochrome *c* oxidase, a drastic reduction of oligomycin-sensitive ATPase activity correlated with the low presence of the ATP synthase complex within the membranes, and a slight decrease of cytochrome *b* content and complex III activity (Bauer *et al.* 1994; Bonnefoy *et al.* 1994a; Altamura *et al.* 1996; He and Fox 1997; Hell *et al.* 1997). Oxa1p presents five hydrophobic segments and is a polytopic inner membrane protein (Herrmann *et al.* 1997; Kermorgant *et al.* 1997; Meyer *et al.* 1997a,b). The study of its import within mitochondria suggests that, during evolution, its import pathway has also been conserved between prokaryotes and eukaryotes (Herrmann *et al.* 1997). Thus, Oxa1p is likely to play a crucial role in all respiring cells in the insertion/assembly of oxidase and ATP synthase complexes within the prokaryote plasma membrane or within the mitochondrial inner membrane, and Hell *et al.* (1998) have recently proposed that Oxa1p could be a component of a general export machinery of the mitochondrial inner membrane.

Corresponding author: Geneviève Dujardin, Centre de Génétique Moléculaire du C.N.R.S., Avenue de la terrasse, 91198 Gif-sur-Yvette Cedex, France. E-mail: dujardin@cgm.cnrs-gif.fr

Interestingly, overexpression of the *OXA1* gene suppresses respiratory defects associated with the single or double inactivation of *RCA1* and *AFG3* (Rep *et al.* 1996a). Rca1p, Afg3p, as well as Yme1p, belong to the ATP-dependent protease family and constitute the chaperone/protease system specific for inner membrane proteins (Thorness *et al.* 1993; Tzagoloff *et al.* 1994; Artl *et al.* 1996; Rep and Grivell 1996b; see Suzuki *et al.* 1997 and references therein). Thus, the genetic interaction between Rca1p/Afg3p and Oxa1p suggests that a tight cooperation exists between these chaperones/proteases and the assembly-assisting factors. Although the mechanism of action of the first ones was recently the subject of numerous studies, the function of Oxa1p or other proteins participating in mitochondrial respiratory complex formation is still poorly understood.

In this article, we present the isolation, molecular cloning, and sequencing of five independent nuclear suppressor mutations that restore the insertion/assembly of both cytochrome *c* oxidase and ATPase in the absence of Oxa1p. The five suppressor mutations are all located in the membrane anchor of cytochrome *c1*, the catalytic subunit of complex III. However, we show that the suppressor function is independent of the electron transfer activity of cytochrome *c1*. As new carbonate-extractable forms of cytochrome *c1* are detected in all the suppressors, we discuss the possible role of soluble forms of cytochrome *c1* in preventing the degradation of subunits that occurs when the insertion/assembly of respiratory complexes is perturbed by the *oxa1* inactivation.

MATERIALS AND METHODS

Media, strains, genetic methods and transformation: Media used for *Saccharomyces cerevisiae* have been described in Dujardin *et al.* (1980); YPG: 1% Yeast extract, 1% bacto-peptone, 2% galactose, 0.1% glucose, 20 μ g/ml adenine. Glucose or galactose were used as fermentable substrates, and glycerol or ethanol as respiratory substrates. Genotype and construction of yeast strains are summarized in Table 1. Yeast genetic methods (crosses, cytoductions, *rho*^o strain construction, and genetic nature of suppressors) were described in Dujardin *et al.* (1980) and Bonnefoy *et al.* (1994a).

Isolation of genetic suppressors: Respiratory-competent revertants were selected from strains carrying an *oxa1::LEU2* allele and either an intron-containing mitochondrial genome (NBT1) or an intron-free mitochondrial genome (NBT2; Table 1). Yeast cells were grown to late logarithmic phase, plated on glucose medium, and UV-irradiated in the dark for 5–20 sec at 254 nm. Irradiated plates were incubated for 3 days at 28°, and then replica-plated on glycerol medium. Among 3.10¹⁰ UV-mutagenized cells, six independent revertants able to grow on glycerol medium were selected.

Isolation of mitochondria and respiratory chain activities: Yeast cells were grown on YPG medium and mitochondria were purified after disrupting cells either by the enzymatic method (Kermorgant *et al.* 1997) or mechanically (Brasseur *et al.* 1995). The mitochondrial protein concentration was determined using the Bio-Rad (Hercules, CA) assay. The respiratory activities were measured at 25°, except ATPase activity

performed at 30°, in EDTA 50 μ M, potassium phosphate 50 mM, pH 7.4. The activities of complexes II, III, and II plus III were measured as described by Brasseur *et al.* (1995). Cytochrome *c* oxidase activity was determined according to Pajot *et al.* (1976). The ATPase activity was determined according to Pullman *et al.* (1960), except that 0.1 mM NADH was used, and 4 mM cyanide was added to inhibit respiration. Cytochrome contents of purified mitochondria were determined spectrally as described in Brasseur *et al.* (1995).

Western blot of mitochondrial proteins: Mitochondria were treated with sodium carbonate according to Kermorgant *et al.* (1997). LDS acrylamide gel electrophoresis was performed according to Dutta and Henry (1990) and electrotransferred. Immunodetection was carried out using the enhanced chemiluminescence method from Pierce Chemical (Rockford, IL). The monoclonal antibody anti-yeast Cox2p was purchased from Molecular Probes (Eugene, OR). The polyclonal antibody anti-yeast Cox6p was kindly provided by R. O. Poyton (Boulder, CO).

Construction of a yeast genomic library from the suppressor strain R14: A new plasmid allowing a positive selection of inserts was constructed from pON163 (Weilguny *et al.* 1991). pON163 was digested by *Clal* and self-ligated. The resulting plasmid was cut by *EcoRI*, blunt ended with Klenow enzyme, and ligated with a 1.1-kb blunt-ended *BglII* fragment containing the *S. cerevisiae URA3* gene to give pNB30. pNB30 was then digested with *Clal* and ligated with a 0.5-kb *Clal* fragment carrying the origin of replication from the 2 μ plasmid. CsCl-purified nuclear DNA from R14 was partially digested with *HindIII* and ligated with the *HindIII*-digested YEpNB33. The ligated DNA was used to transform electro-competent *Escherichia coli* cells to both ampicillin and kanamycin resistance. About 260,000 independent transformants were recovered. The library DNA was purified and used to transform the *oxa1::LEU2* strain NBT2.

Cloning and sequencing of the wild-type *CYT1* and suppressor alleles: YEpPH65 (see Figure 3) was cut by *HpaI* and self-ligated to give YEpPH66, which only carries the *CYT1* gene. YEpPH66 was cut by *BstEII* and *SwaI*, gel purified, and used to transform the strains CW30, NBT2, R101, and R118 to uracile prototrophy. Gap-repaired plasmids were characterized by restriction analysis, and the C-terminal region of the *CYT1* gene was sequenced. PCR amplification was also carried out on genomic DNA extracted from the five suppressors, and the amplification products were sequenced on both strands using the sequenase PCR product sequencing kit (United States Biochemical, Cleveland).

Construction of a *CYT1-1 OXA1* strain: A *cyt1::LEU2* strain was constructed by introducing the 2.7-kb *LEU2* fragment at the *NsiI* site internal to *CYT1* gene. Molecular and genetic analyses were carried out as described in Bonnefoy *et al.* (1994a) to verify the *CYT1* inactivation. As expected the *cyt1::LEU2* strain (PHT3) is deficient for respiration, and cytochrome spectra show a complete lack of cytochrome *c1*. The *CYT1-1* strain (PHT31) was constructed by transforming PHT3 with YEpPH65 and selecting respiratory-competent transformants that had lost the leucine prototrophy. Sequencing of the 3' end of the *CYT1* gene of these transformants showed that they contain the *CYT1-1* mutation.

Construction of a cytochrome *c1* gene carrying both the *CYT1-1* and the *cyt1-164* mutations: YEpPH219 and YEpPH220 are multicopy plasmids carrying either the *CYT1* or the *CYT1-1* cDNA. PCR mutagenesis was carried out using two oligonucleotides: O1 (5'GTGAAGTTTGTGCCGCTG3') and the mutagenic oligonucleotide O5 (5'GCGGGGTACCATCTTCGTACTCAACCATGTCATCAAACAAGACTCTTGCTTTGCAATGGAACC3') carrying the mutation CAT to CTT (M₁₆₄ to K₁₆₄). The PCR product was cut with *AgeI* and *KpnI* and cloned in

TABLE 1
List of yeast strains

Strains	Nuclear genotype	Mitochondrial genome
CW30 ^a	α , <i>ade2-1 ura3-1 his3-11,15 trp1-1 leu2-3,112 can1-100</i>	Δ i
CW04 ^a	α , <i>ade2-1 ura3-1 his3-11,15 trp1-1 leu2-3,112 can1-100</i>	Σ i
NBT2	α , <i>ade2-1 ura3-1 his3-11,15 trp1-1 leu2-3,112 can1-100 oxa1::LEU2</i>	Δ i
NBT1 ^a	α , <i>ade2-1 ura3-1 his3-11,15 trp1-1 leu2-3,112 can1-100 oxa1::LEU2</i>	Σ i
R101 (R118, R121)	α , <i>ade2-1 ura3-1 his3-11,15 trp1-1 leu2-3,112 can1-100 oxa1::LEU2 CYT1-1 (CYT1-3, CYT1-2)</i>	Δ i
R14 (R18)	α , <i>ade2-1 ura3-1 his3-11,15 trp1-1 leu2-3,112 can1-100 oxa1::LEU2 CYT1-1 (CYT1-4)</i>	Σ i
R14/G481	α , <i>ade2-1 ura3-1 his3-11,15 trp1-1 leu2-3,112 can1-100 oxa1::LEU2 CYT1-1</i>	<i>cox1-G481</i> Σ i
PHT31	α , <i>ade2-1 ura3-1 his3-11,15 trp1-1 leu2-3,112 can1-100 CYT1-1</i>	Δ i
PHT3	α , <i>ade2-1 ura3-1 his3-11,15 trp1-1 leu2-3,112 can1-100 cyt1::LEU2</i>	Δ i

Σ i, mitochondrial genome with 13 introns; Δ i, mitochondrial genome devoid of all introns. NBT2 was constructed by cytoducting an intron-free mitochondrial genome into the *rho*^o derivative (strain devoid of mitochondrial genome) of NBT1. The suppressor strains R14 and R18 were obtained from the strain NBT1, and R101, R118, and R121 from the strain NBT2 (see results). R14/G481 was constructed by cytoducting an intron-containing mitochondrial genome carrying the mitochondrial *cox1-G481* mutation into the *rho*^o derivative of R14. The construction of the strains PHT31 and PHT3 is described in materials and methods.

^aSee Bonnefoy *et al.* 1994a.

AgaI/KpnI-digested plasmid YEpPH220 to give YEpPH221. We have shown by DNA sequencing that the resulting cytochrome *c1* gene carried by YEpPH221 contains both mutations (K₁₆₄ and K₂₁₆).

RESULTS

Extragenic suppressors can compensate for the respiratory deficiency due to the inactivation of the *OXA1* gene: In the search for genetic interactions involving the *OXA1* gene, both the two-hybrid and suppressor strategies could *a priori* be used. However it is well known that the two-hybrid system is difficult to utilize with highly hydrophobic membrane proteins such as Oxa1p. Thus, we decided to search for suppressor genes that were able to alleviate the respiratory defect of *oxa1*-null mutants. We were unable to isolate any multicopy suppressors, but six independent genetic suppressor strains were isolated and characterized further (see materials and methods). The six suppressor mutations all correspond to extragenic dominant nuclear mutations. Recombination was never detected between suppressor mutations from R14, R18, R101, R118, and R121, suggesting that they are probably located in the same gene, whereas R102 is not allelic to the other five. The study of the first five suppressor strains was continued further. The suppressor strains R14 to R121 (see Table 1) show different levels of growth on respiratory substrates (Figure 1A and data not shown). All seemed to display a thermosensitive growth at 36° on nonfermentable medium, suggesting that they cannot replace Oxa1p at high temperatures. Cytoduction of an intron-less mitochondrial genome in the R14 and R18

nuclear backgrounds (and, reciprocally, cytoduction of an intron-containing mitochondrial genome in the R101, R118, and R121 nuclear backgrounds) showed that the compensatory effect is always much stronger in the absence rather than in the presence of mitochondrial introns (Figure 1A). We have previously shown that the major effect of the *oxa1* inactivation occurs at a post-translational stage, but that it also leads to pleiotropic secondary defects in the accumulation of intron-containing mitochondrial RNA (Bonnefoy *et al.* 1994b). The difference in suppression observed between intron-free and intron-containing strains suggests that the suppressors do not accommodate these secondary defects.

The activities of both the cytochrome *c* oxidase and ATPase complexes are restored in the suppressor strains: As we had previously shown that Oxa1p is necessary for the activities of the cytochrome *c* oxidase and ATPase complexes (Altamura *et al.* 1996), we have also determined these activities in the suppressor strains. The results are presented for only one or two representative suppressor strains because the data were similar for all five strains.

As shown in Figure 1B, at least 80% of the oligomycin-sensitive ATPase activity and ~30–50% of cytochrome *c* oxidase activity were restored in the different suppressor strains. Thus, the ATPase activity is restored to nearly wild-type level, whereas cytochrome *c* oxidase activity is only partially recovered. A partial restoration of the cytochrome *aa3* spectrum was also observed in the suppressor strains (Figure 2A and data not shown), indicating that some heme *aa3* is correctly assembled within

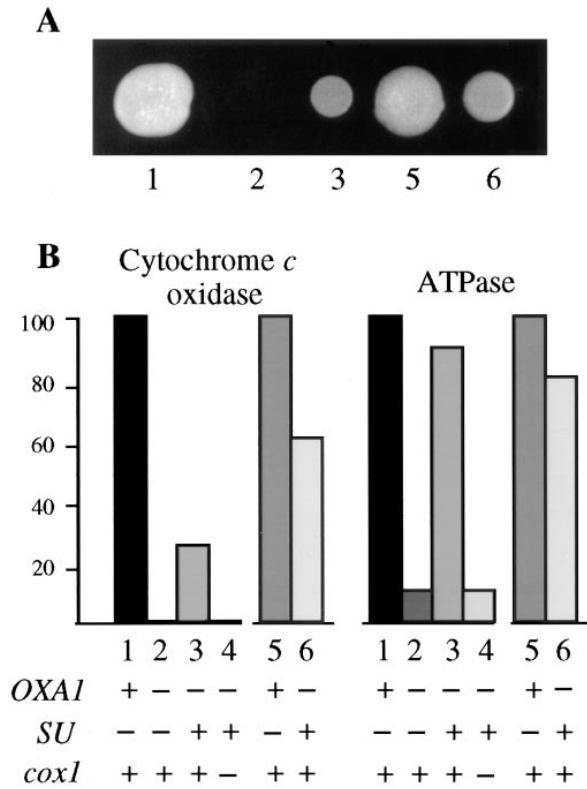

Figure 1.—Respiratory growth, cytochrome *c* oxidase, and oligomycin-sensitive ATPase activities of the suppressor strains. (1) Wild type (CW04); (2) *oxa1::LEU2* mutant (NBT1); (3) suppressor strain R14; (4) suppressor strain carrying the *cox1-G481* mutation (R14/G481); (5) wild type (CW30); (6) suppressor strain R101. See Table 1 for the complete genotype of strains. R14 and R101 carry the same nuclear suppressor mutation (see Figure 3) and only differ by their mitochondrial genome. Restoration of respiratory growth (A): Strains were grown on ethanol medium as a respiratory substrate and incubated 5 days at 28°. Enzymatic activities (B): Mitochondria were purified and respiratory enzyme activities were measured as described in materials and methods. Activities are the mean values of several independent experiments. The suppressor activities are normalized to the values obtained for the corresponding wild-type strain. Cytochrome *c* oxidase activity: 540 ± 19 and 547 ± 50 nmol cytochrome *c*-oxidized/min/mg mitochondrial protein and oligomycin-sensitive ATPase 485 ± 55 and 638 ± 65 nmol ATP-hydrolyzed/min/mg for CW30 and CW04, respectively. —, wild-type gene with no suppressor activity for the suppressor (SU).

the complex IV. The activity/heme *aa3* ratio measured in mitochondria shows that the turnover of complex IV is unchanged, indicating that cytochrome *c* oxidase is fully active but present in lower amounts in the suppressor strains. Analysis of mitochondrial translation products by $^{35}\text{SO}_4$ labeling shows that Cox1p, Cox2p, and Cox3p are translated at the same level as in the wild type and that the correct proteolytic cleavage of Cox2p is fully restored in the suppressor strains (Figure 2B and data not shown). However, an analysis of the steady-state level of these three subunits by immunoblotting shows that Cox2p, which is not detectable in the

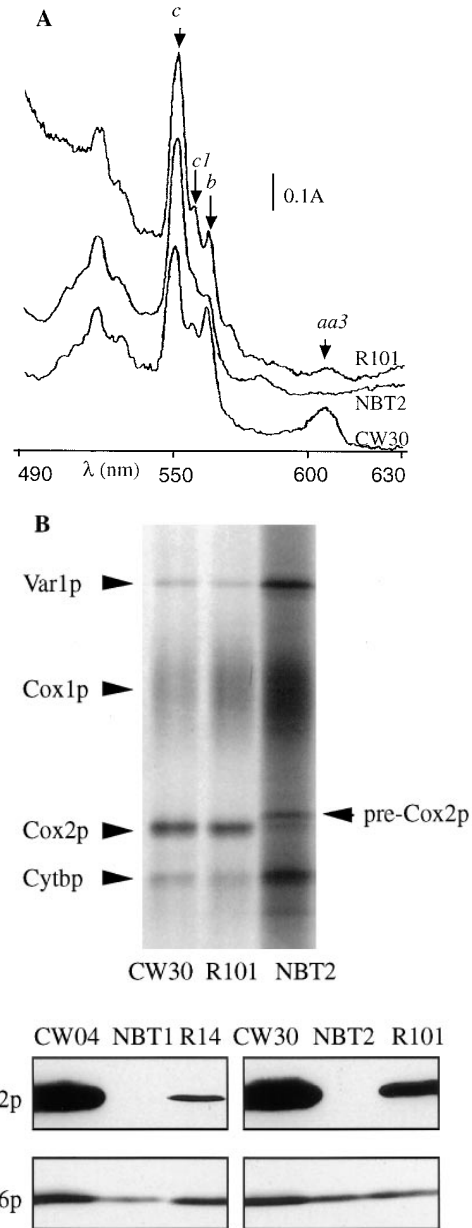

Figure 2.—Cytochrome *c* oxidase assembly in the suppressor strains. Cytochrome spectra and mitochondrial translation products from wild-type (CW04 or CW30), *oxa1::LEU2* mutant (NBT1 or NBT2), and suppressor (R14 or R101) cells were analyzed. Cytochrome spectra (A): Low-temperature cytochrome absorption spectra of galactose-grown cells were recorded as described in Bonnefoy *et al.* (1994a). Arrows, absorption maxima of the alpha bands of cytochromes *c* (546 nm), *c1* (552 nm), *b* (558 nm), and *aa3* (602 nm). Cox2p maturation (B): Mitochondrial translation products were labeled with $^{35}\text{SO}_4$ in the presence of cycloheximide, as described in Bonnefoy *et al.* (1994a), and analyzed by a long electrophoresis in a 12.5% SDS acrylamide gel to differentiate precursor (pre-Cox2p) and mature (Cox2p) forms. In these conditions, Cox3p is run out of the gel. Arrowheads, variant 1 ribosomal protein (Var1p), mitochondrial subunits I and II of cytochrome *c* oxidase (Cox1p and Cox2p, respectively), and apocytochrome *b* (Cytbp). Immunodetection of Cox2p and Cox6p (C): About 40 μg of mitochondrial membranes were separated by 15–25% SDS acrylamide gradient gels and analyzed by Western blotting with anti-Cox2p and anti-Cox6p. Under these gel electrophoresis conditions, the precursor and mature forms of Cox2p comigrate.

oxa1::LEU2 mutant, is present in lower than wild-type amounts in the suppressor strains (Figure 2C). The same observation was made for Cox1p and Cox3p (data not shown). As a control, the nuclear-encoded subunit Cox6p, which is only slightly affected by the *oxa1::LEU2* mutation, was used; Cox6p is present in normal amounts in the suppressor strains. Thus, a fully active cytochrome *c* oxidase complex, with a correctly matured Cox2p, is present in the suppressors but at lower levels than in the wild type, and the ATPase complex is fully active in the suppressor strains. Thus, the suppressor mutations are able to compensate for both the cytochrome *c* oxidase and the ATPase activity defects due to the absence of Oxa1p.

Because the suppressors compensate for both the cytochrome *c* oxidase and the ATPase activity defects, we have asked whether the restoration of ATPase activity could occur independently of that of cytochrome *c* oxidase. We have constructed a suppressor strain R14/G481 carrying the mitochondrial mutation *cox1-G481*. This mutation, located in the gene coding for subunit 1 of the cytochrome *c* oxidase gene, results in a lack of heme *aa3* and cytochrome *c* oxidase activity consequent to the absence of the Cox1p subunit, but does not impair oligomycin-sensitive ATPase activity (Altamura *et al.* 1996). As shown in Figure 1B, the cytochrome *c* oxidase activity of the strain R14/G481 is nil, and the ATPase activity is reduced to the residual level measured in the *oxa1::LEU2* mutant (Figure 1B). Thus, cytochrome *c* oxidase is required for the restoration of the ATPase activity.

The suppressor mutations are all located in the membrane anchor of cytochrome *c1*: To identify the suppressor gene, we have constructed a genomic library from the suppressor strain R14 in a shuttle yeast *E. coli* vector, allowing a positive selection of recombinant plasmids (see materials and methods). The *oxa1::LEU2* strain was transformed with this library, and two respiratory-competent transformants were obtained. From these, two different recombinant plasmids, named YEpPH65 and YEpPH622, containing overlapping inserts, were isolated. YEpPH65 contains a 11.2-kb *HindIII* fragment with one internal *HindIII* site (Figure 3), while YEpPH622 carries a larger insert that includes all the YEpPH65 insert. The cloned fragment was located on the yeast chromosomes by sequencing the two extremities of the YEpPH65 insert. Comparison to the yeast genome sequence revealed that we had cloned a fragment from chromosome XV, encompassing six open reading frames (ORFs). By deleting either the 9.5-kb *HpaI* or the 9.8-kb *HpaI/SwaI* restriction fragment from YEpPH65, we could restrict the region responsible for the suppression to the 1.3-kb *HindIII/SwaI* fragment with an internal *HindIII* site. This region contains the *CYT1* gene that encodes the cytochrome *c1*, a catalytic subunit of complex III of the respiratory chain. The 1.3-kb fragment includes a truncated form of the *CYT1*

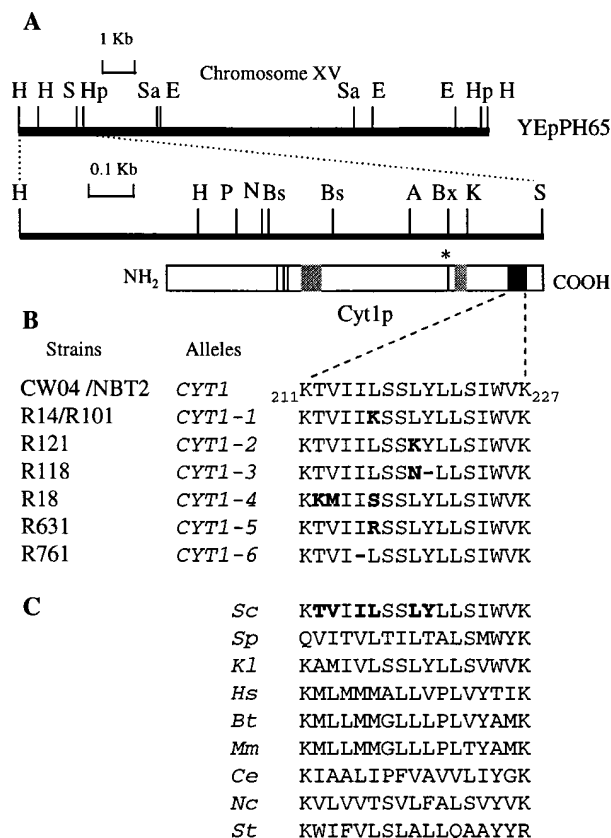

Figure 3.—Localization and sequence of the suppressor mutations in the cytochrome *c1* gene. Cloning of the suppressor gene (A): Upper bar, restriction map of the recombinant plasmid (YEpPH65) carrying the suppressor gene and isolated from the R14 library. Lower bar, detailed restriction map of the shortest fragment which confers suppression (1.3 kb *HindIII-SwaI*). This fragment contains the *CYT1* gene, and the general structure of Cyt1p is presented underneath (for review see Trumpower 1990; Xia *et al.* 1997; Zhang *et al.* 1998). Four vertical lines, position of heme *c1* ligands. Grey boxes, acidic regions involved in binding to cytochrome *c*. Black block, anchor domain. *, position of the *cyt1-164* mutation. H, *HindIII*; S, *SwaI*; Hpa, *HpaI*; E, *EcoRI*; P, *PvuII*; N, *NsiI*; Bs, *BstEII*; A, *AgeI*; Bx, *BstXI*; K, *KpnI*; Sa, *SalI*. Sequence of the suppressor mutations (B): Sequence of the cytochrome *c1* present in wild-type (CW04), *oxa1::LEU2* mutant (NBT2), and suppressor strains was determined. The suppressors R631 and R761 were subsequently isolated from an *oxa1::URA3* mutant. Boldface, amino acids that are changed in the suppressors. Sequence alignment of the membrane anchors (C): Amino acid sequences of the mitochondrial inner membrane anchor of cytochrome *c1* from various eukaryotes were retrieved from the SWISSPROT database and aligned. *Sc*, *Saccharomyces cerevisiae*; *Sp*, *Schizosaccharomyces pombe*; *Kl*, *Kluyveromyces lactis*; *Hs*, *Homo sapiens*; *Bt*, *Bos taurus*; *Mm*, *Mus musculus*; *Ce*, *Caenorhabditis elegans*; *Nc*, *Neurospora crassa*; *St*, *Solanum tuberosum*. Boldface, amino acids of the *S. cerevisiae* wild-type sequence that are changed in the suppressor genes.

promoter, the open reading frame, and 23 bases following the stop codon.

The fragment carrying the suppressor function was sequenced and compared to the sequence of the *CYT1* gene present in the control wild-type strains. Two nucle-

otide substitutions (TTA to AAA) were found at positions 831 and 832, corresponding to codon 216 of the *CYT1* ORF, changing a leucine into a lysine residue (Figure 3). The wild-type sequence was in agreement with the sequence published by Sadler *et al.* (1984).

We have cloned the other suppressor alleles by gap repair (see materials and methods). Gap-repaired plasmids, as well as PCR amplification of genomic DNA, were used to sequence the suppressor mutations. All of the suppressor mutations occur in the same C-terminal domain of Cyt1p, and the same amino acid substitution is found in R14 and R101 that was isolated from two different *oxa1::LEU2* strains (Figure 3). This C-terminal domain is highly hydrophobic, depicted as an α -helix in the wild type, and constitutes the anchor of cytochrome *c1* in the mitochondrial inner membrane (for review see Trumpower 1990; Xia *et al.* 1997; Zhang *et al.* 1998). As a control, we have verified that the cloning on a multicopy plasmid of the wild-type cytochrome *c1*-encoding gene does not suppress the *oxa1* inactivation.

Comparison of the amino acid sequences of cytochrome *c1* from yeast and other eukaryotes (Figure 3C) shows that the membrane anchor is conserved and always highly hydrophobic. All of the suppressor mutations appear to decrease the hydrophobicity of the cytochrome *c1* anchor. *CYT1-1* and *CYT1-2* replace a leucine residue with a lysine residue at positions 216 (L216K) and 219 (L219K), respectively. *CYT1-3* mutation is due to the substitution of a leucine by an asparagine (L219N) and to the deletion of the adjacent tyrosine, leading to a shorter and less hydrophobic anchor. *CYT1-4* carries three substitutions, T212K, V213M, and L216S. Such multiple mutation events are often observed at or near the sites of dimers with UV mutagenesis in the dark, particularly in A/T-rich regions. The three mutations detected in the *CYT1-4* allele are located in such an A/T-rich region. The V213M substitution is probably silent because there is a methionine at this position in the yeast *Kluyveromyces lactis*. The substitution T212K replaces a neutral residue with a hydrophilic one, and substitution L216S replaces a hydrophobic residue with a neutral one. Finally, the *CYT1-5* and *CYT1-6* mutations were subsequently isolated from an *oxa1::URA3* mutant: *CYT1-5* replaces the leucine 216 with an arginine (L216R), and *CYT1-6* corresponds to the deletion of the isoleucine 215. Both mutations also diminish the hydrophobicity of the anchor.

Carbonate-extractable forms of cytochrome *c1* are present in the suppressor strains: The fact that the suppressor activity is due to various amino acid substitutions all leading to a decrease in the hydrophobicity of the anchor domain suggests that these substitutions could modify the binding of cytochrome *c1* to the membrane. *A priori*, two methods of fractionation, osmotic swelling and carbonate extraction, could be used to separate membrane and soluble proteins. However, it is known that upon osmotic swelling, the soluble cytochrome *c*

stays mainly associated with the membrane through electrostatic interactions. In contrast, cytochrome *c* is well extracted by carbonate treatment, so we used this technique to study the binding of cytochrome *c1* to the membrane in the various suppressor strains. As expected from previous work (Hase *et al.* 1987b), cytochrome *c1* is totally resistant to carbonate extraction in *CYT1 OXA1* strains (CW04 or CW30) because it is tightly anchored within the inner membrane (see Figure 4). Cytochrome *c1* is also completely resistant to carbonate extraction in *CYT1 oxa1::LEU2* strains (NBT1 or NBT2). In the suppressor strains, membrane-bound form of cytochrome *c1* is still present but in addition, minor fast-migrating forms are found in the supernatant. These extractable forms are systematically detected in the different suppressors, which were independently isolated from different *oxa1*-null mutants (Figure 4 and data not shown). Thus, the suppressor mutations seem to modify the insertion of cytochrome *c1* into the mitochondrial inner membrane.

The suppressor mutation *CYT1-1* does not affect complexes II and III maximal activities: Cytochrome *c1* is a catalytic subunit essential for electron transfer between complex III and cytochrome *c*. To determine whether the suppressor mutation located in the membrane anchor of cytochrome *c1* affects the activity of complex III, we constructed a strain carrying the mutation *CYT1-1* in an *OXA1* context (PHT31, see Table 1 and materials and methods). This strain is respiratory competent, exhibits a complex III maximal activity, and cytochrome spectra similar to that of wild-type *CYT1* strain (see Figure 5, A and B). Measurements of heme *b* content in mitochondria showed that the turnover of complex III is also unaffected, although a slight modification of the kinetic interaction between cytochrome *c* and complex III cannot presently be ruled out. Bruel *et al.* (1996) have described mutants of the complex III subunit 8 which do not affect complex III activity but decrease the complex II activity. Therefore, we have measured the complex II maximal activity in *CYT1-1* cells. Figure 5A shows that complex II maximal activity is not significantly decreased by the *CYT1-1* mutation.

Carbonate extraction of *CYT1-1* mitochondria (Figure 5C) reveals that all the cytochrome *c1* is found in the pellet, suggesting that the cytochrome *c1* insertion is not modified by the *CYT1-1* mutation in a wild-type *OXA1* genetic background. Thus, the carbonate-extractable forms are only detected when suppressor mutations are associated to the *oxa1::LEU2* inactivation.

Suppressor function is independent of the electron transfer activity: To directly test the relationship between the suppressor and the electron transfer activity of cytochrome *c1*, we have constructed a *CYT1* gene carrying both the suppressor mutation *CYT1-1* and the mutation *cyt1-M164K* (see materials and methods). The M164K mutation was chosen because it drastically decreases the complex II plus III activity without

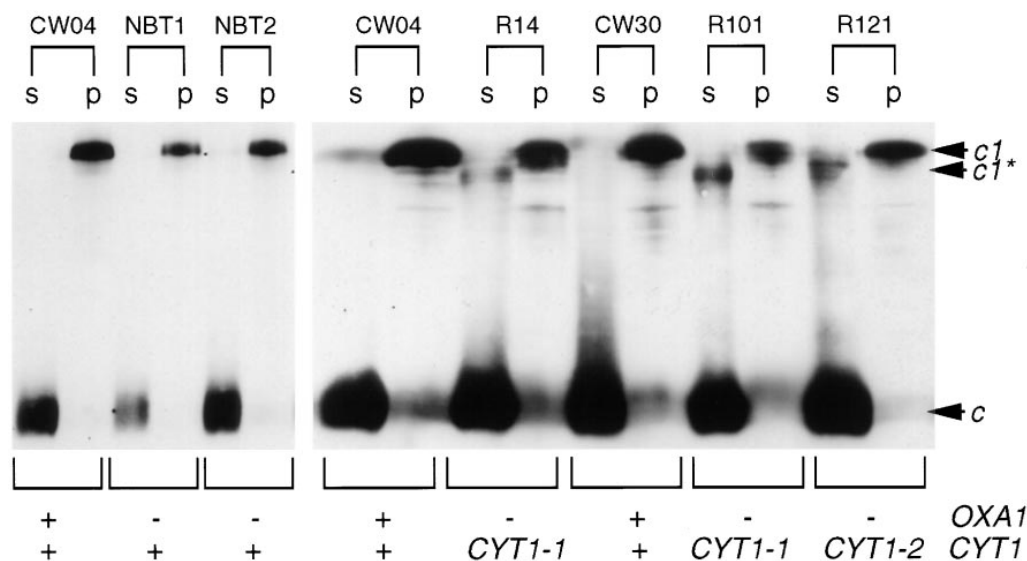

Figure 4.—Carbonate extraction of cytochrome *c1* in the suppressor strains. 300 μ g of mitochondria from wild type (CW04 or CW30), *oxa1::LEU2* (NBT1 or NBT2), and suppressors (R14, R101, and R121) were treated with sodium carbonate, and the supernatants (s) and pellets (p) were migrated separately on 12% LDS-PAGE gels and transferred to a nitrocellulose filter. Detection of *c*-type cytochromes was performed on the membrane as described by Vargas *et al.* (1993). Arrows, positions of cytochrome *c* (*c*) and membrane-bound (*c1*) and carbonate-extractable (*c1**) forms of cytochrome *c1*. Note that for NBT1 and NBT2, no carbonate-extractable forms were detected even after overexposure.

blocking cytochrome *c1* assembly in complex III (Nakai *et al.* 1990). We have determined whether the double-mutant *cyt1-1,164* is still able to compensate for the absence of Oxa1p. As expected the plasmid YEpPH220

carrying the *CYT1-1* mutation partially restores the respiratory defect due to the *oxa1::LEU2* mutation, and YEpPH221, which carries the double-mutant *cyt1-1,164*, does not complement the respiratory deficiency due to

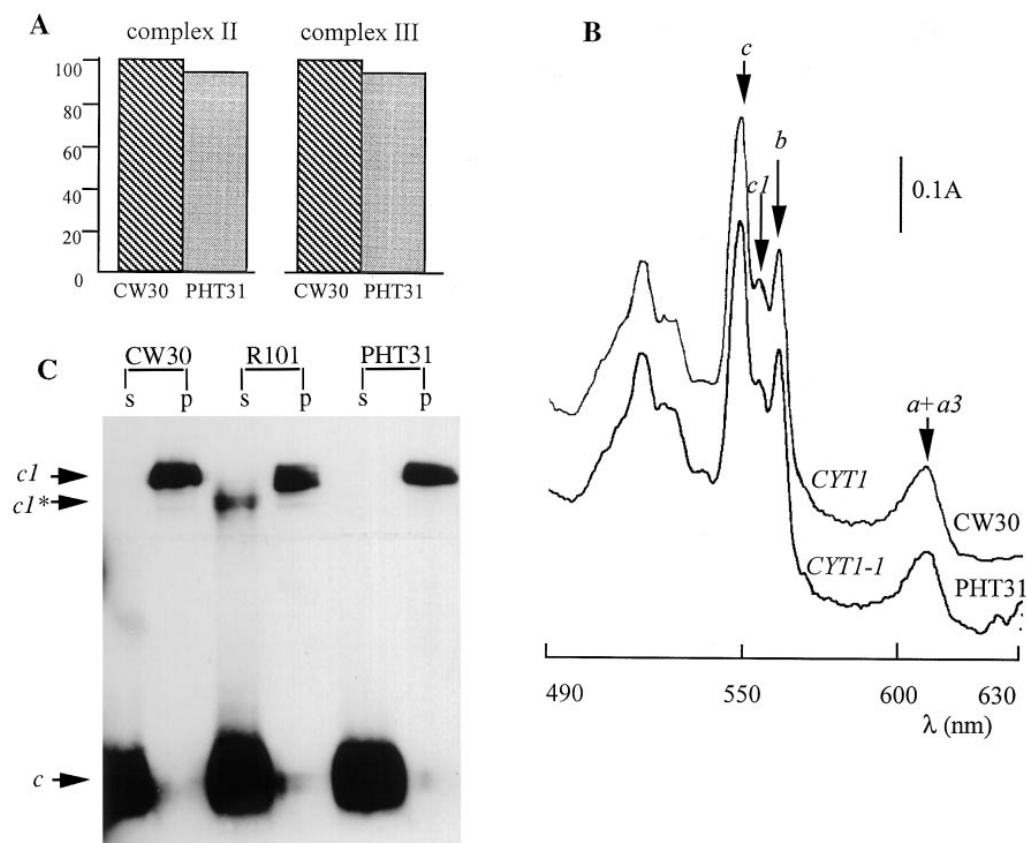

Figure 5.—Complexes II and III maximal activities and carbonate extraction in *CYT1* strains. CW30, *OXA1* *CYT1*; PHT31, *OXA1* *CYT1-1*; R101, *oxa1::LEU2* *CYT1-1*. (A) Complex II (succinate-decylubiquinone reductase) and complex III (decylubiquinol-cytochrome *c* reductase) maximal activities of purified mitochondria. All activities are mean values of several independent experiments and normalized to the values obtained for the wild-type strain (CW30): succinate-decylubiquinone reductase (II), 136 ± 7 nmol decylubiquinone-reduced/min/mg mitochondrial protein; decylubiquinol-cytochrome *c* reductase (III), 91 ± 40 nmol cytochrome *c*-reduced/min/mg mitochondrial protein. (B) Cytochrome spectra (as in Figure 2A). (C) Carbonate extraction of mitochondria (as in Figure 4).

the *cyt1::LEU2* inactivation (see Figure 6); the complex II plus III activity measured in these latter transformants (*cyt1::LEU2/YEpPH221*) was found to be 10% of the level measured in the *cyt1::LEU2* strain transformed by YEpPH219 carrying the *CYT1* gene. On the contrary, *CYT1 oxa1::LEU2* cells transformed by YEpPH221 (*cyt1-1,164*) are able to grow on respiratory medium (Figure 6). These transformants carry two cytochrome *c1* genes, the chromosomal *CYT1* and the plasmidic *cyt1-1,164* genes. The chromosomal *CYT1* gene is able to ensure full electron transfer activity, but does not have the suppressor activity. Thus, the suppressor activity comes from the plasmidic *cyt1-1,164* gene, which codes for a protein with drastically reduced electron transfer activity. This result strongly suggests that the suppressor activity of the mutant cytochrome *c1* is independent of its catalytic activity in electron transfer.

DISCUSSION

Oxa1p is a mitochondrial inner membrane protein that is required for the insertion/assembly of the respiratory complexes. Oxa1p seems to be present in all aerobic organisms, and we have shown here that in yeast, it is possible to isolate suppressors which compensate for the absence of Oxa1p at 28°. In the suppressor strains, the oligomycin-sensitive ATPase activity is fully restored and there is a partial recovery of cytochrome *c* oxidase activity. Turnover measurements and steady-state levels

oxa1::LEU2/YEpPH221 *cyt1::LEU2/YEpPH221*
(*cyt1-1,164*) (*cyt1-1,164*)

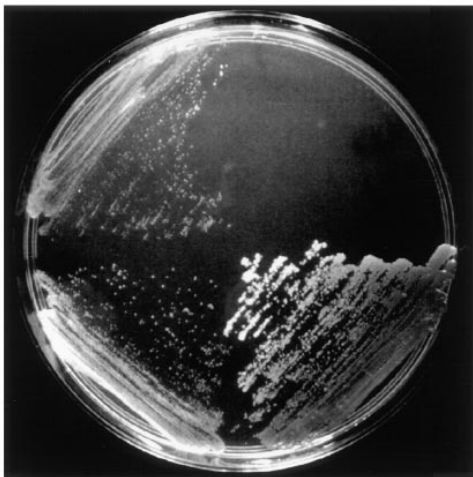

oxa1::LEU2/YEpPH220 *cyt1::LEU2/YEpPH220*
(*CYT1-1*) (*CYT1-1*)

Figure 6.—Compensation for the *oxa1* inactivation by a catalytically inactive cytochrome *c1*. The *cyt1::LEU2* strain (PHT3) and the *oxa1::LEU2* strain (NBT2) were transformed by plasmids carrying the *CYT1* gene, with either the suppressor mutation *CYT1-1* (YEpPH220) or the double mutations *cyt1-1,164* (YEpPH221). Transformants were streaked on non-fermentable medium and incubated at 28°.

of mitochondrial subunits show that the assembled complex IV is fully active but present in reduced amounts within the membranes. We have cloned the suppressor gene and shown that it corresponds to *CYT1* that encodes cytochrome *c1*.

Cytochrome *c1* is a catalytic subunit of complex III, it transfers the electrons from complex III to cytochrome *c* and is conserved in bacterial and eukaryotic systems. The protein has a bipartite structure with a large N-terminal hydrophilic domain (often called the soluble

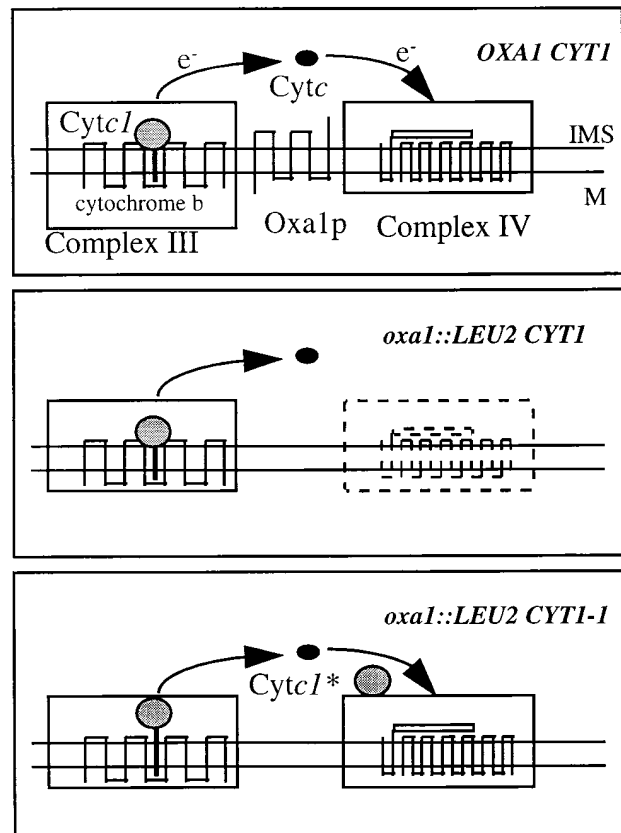

Figure 7.—Model to explain suppressor activity. Complex III, rectangle including the eight membrane-spanning helices of Cytbp; bold line, cytochrome *c1* anchor; gray circle, hydrophilic region of the molecule exposed to the intermembrane space (IMS). Complex IV, rectangle including the 12 membrane-spanning helices of Cox1p and a schematic representation of Cox2p (membrane-spanning helices and a rectangle that represents the hydrophilic part extending in the IMS). The topological arrangement of Oxa1p within the inner membrane is drawn according to Herrmann *et al.* (1997). Arrows, electron flux (e^-) from cytochrome *c1* to cytochrome *c* (black circle) and complex IV. *OXA1 CYT1*: Oxa1p is present in the membrane, the respiratory complexes are correctly assembled, and electron transfer proceeds normally from complex III to complex IV via cytochrome *c*. *oxa1::LEU2 CYT1*: Oxa1p is absent, complex IV cannot assemble, and some subunits are degraded by proteases. Electron flow is blocked between cytochrome *c* and complex IV. *oxa1::LEU2 CYT1-1*: A mutation in the membrane anchor of Cyt1p modifies its insertion into the inner membrane and generates soluble forms of the molecule that prevent mitochondrial cytochrome *c* oxidase subunits from degradation.

domain) that is located in the intermembrane space and binds the heme *c1* and a short C-terminal domain composed of a stretch of hydrophobic amino acids, responsible for the binding to the mitochondrial inner membrane (Li *et al.* 1981; for review see Trumpower 1990; Xia *et al.* 1997). In *S. cerevisiae*, replacement of a large part of the C-terminal region by a foreign sequence leads to a loss of assembly and activity of the complex III, due to modified binding of cytochrome *c1* to the inner membrane (Hase *et al.* 1987a,b). Similarly, in *Rhodobacter sphaeroides*, deletion of the C-terminal domain results in a soluble protein located in the periplasmic space, which is no longer catalytically active although heme *c1* is correctly bound to the apoprotein (Konishi *et al.* 1991). All suppressor mutations described here correspond to amino acid substitutions that diminish the hydrophobicity of the C-terminal membrane anchor. These mutations do not seem to affect the electron transfer activity of complex III. Moreover, a cytochrome *c1* with drastically reduced electron transfer activity and that carries the suppressor mutation *CYT1-1* still retains the suppressor activity. Together, these results show that the suppressor function of cytochrome *c1* is independent of its electron transfer activity.

It has been shown that *oxa1* mutants *in vivo* affect the insertion/assembly of complexes IV and V and to a lesser extent of complex III, and that proteolysis occurs leading to the degradation of the mitochondrial subunits of complex IV (Altamura *et al.* 1996; Meyer *et al.* 1997b and this study). When the *oxa1* mutant is combined with the *CYT1* suppressor mutations, faster migrating carbonate-extractable forms of cytochrome *c1* are observed, which are probably soluble forms resulting from proteolysis. We suspect that in an *oxa1*⁻ context where insertion of respiratory complex subunits is already perturbed (He and Fox 1997; Hell *et al.* 1997, 1998), the presence of the mutations in the anchor of cytochrome *c1* slows down the insertion into the membrane sufficiently to allow proteolysis to occur, producing the carbonate-extractable forms of cytochrome *c1* detected in our experiments.

These new carbonate-extractable forms of cytochrome *c1* are probably catalytically inactive as the association to the membrane is essential for electron transfer (Konishi *et al.* 1991), and we propose that these new forms are responsible for the suppressor function (Figure 7). It is unlikely that these carbonate-extractable forms of cytochrome *c1* can replace the inner membrane protein Oxa1p. However, as we have shown that in the absence of Oxa1p, proteolysis occurs leading to the degradation of mitochondrial cytochrome *c* oxidase subunits, we propose that the carbonate-extractable forms of cytochrome *c1* prevent the degradation of these subunits. These new forms of cytochrome *c1* could interact with complex IV either directly or indirectly via its usual partner for the electron transfer function, cytochrome *c*. Indeed, cytochrome *cis* protected from degra-

dation by interactions with cytochrome *c1* or complex IV (Pearce and Sherman 1995a), and cytochrome *c*-deficient mutants present a defect in complex IV correlated to the degradation of Cox2p and Cox3p by the protease Yme1p (Pearce and Sherman 1995b). However, the overexpression of iso-1 or iso-2 cytochrome *c*-encoding genes does not compensate for the absence of Oxa1p, and the inactivation of the gene *YME1* in the *oxa1*-null mutant does not restore the stability of Cox2p (data not shown). Thus, we propose that the carbonate-extractable forms of cytochrome *c1* interact directly with complex IV. To our knowledge, no interactions between cytochrome *c1* (or complex III) and ATP synthase have been reported. Thus, we postulate two interactions to explain the restoration of assembly of the ATP synthase in the suppressor strains: first, an interaction between cytochrome *c1* and complex IV, and then an interaction between complex IV and ATP synthase, which was already reported in bovine mitochondria (Qiu *et al.* 1992).

Although further biochemical experiments will be necessary to determine if the carbonate-extractable forms of cytochrome *c1* are directly responsible for the suppression by interacting with complex IV, several results favor this model. First, in a preliminary experiment, we have detected carbonate-extractable forms of cytochrome *c1* in the suppressor R102 that is not allelic to *CYT1* (data not shown). Second, we have shown that in the strain R14/G481 carrying the *oxa1* null, the suppressor *CYT1-1*, and the *cox1-G481* mutations, and thus displaying no active complex IV, no restoration of the ATPase activity is observed (Figure 1B), although carbonate-extractable forms of cytochrome *c1* are still present (data not shown). This suggests that complex IV is also required for the suppression. Third, Zhang *et al.* (1998) have very recently shown that the structure of the extrinsic domain of cytochrome *c1* shares high similarity to the structure of cytochrome *c*. It is well known that cytochrome *c* directly interacts with complex IV, and Pearce and Sherman (1995b) have shown that cytochrome *c* protects complex IV from degradation. This similarity of structure is consistent with a direct interaction between cytochrome *c1* and complex IV.

Finally, both *OXA1* and *CYT1* are conserved through evolution, and we have cloned and inactivated the *Schizosaccharomyces pombe* homolog of *OXA1* (N. Bonnefoy, unpublished results). Interestingly, the *S. cerevisiae* *CYT1-1* suppressor is also able to suppress the inactivation of the *OXA1* homolog in *S. pombe*. The fact that the suppressor can be exchanged between these two yeasts that are highly diverged suggests that the intricate relationships existing between insertion, assembly, and stability of the respiratory complex subunits are conserved through evolution.

We are grateful to Professor P. P. Slonimski for his constant interest and to Dr. C. J. Herbert for stimulating discussions, critical reading of the manuscript, and for looking over the English. We thank Pr. T. Fox and E. Petrochilo for the gift of strains and plasmids, Dr. D.

Lemesle-Meunier for fruitful discussions and advice in the measurements of enzymatic activities, Dr. O. Groudinsky for critical reading of the manuscript, M. Kermorgant and P. Tron for technical assistance, and the students C. Torchet, F. Nourrit, J.-C. Rain, E. Lerat, C. Germain, and C. Tendeng for their contribution to this work. P.H. was supported by a Ministère de l'Éducation Nationale de l'Enseignement Supérieur, de la Recherche et de l'Insertion Professionnelle (MENRT) grant. This work was supported by grants from the Association Française contre les Myopathies.

LITERATURE CITED

- Altamura, N., N. Capitanio, N. Bonnefoy, S. Papa and G. Dujardin, 1996 The *Saccharomyces cerevisiae* *OXA1* gene is required for the correct assembly of cytochrome *c* oxidase and oligomycin-sensitive ATP synthase. *FEBS Lett.* **382**: 111–115.
- Artl, H., R. Tauer, H. Feldmann, W. Neupert and T. Langer, 1996 The YTA10-12 complex, an AAA protease with chaperon-like activity in the inner membrane of mitochondria. *Cell* **85**: 875–885.
- Bauer, M., M. Behrens, K. Esser, G. Michaelis and E. Pratje, 1994 *PET1402*, a nuclear gene required for proteolytic processing of cytochrome oxidase subunit 2 in yeast. *Mol. Gen. Genet.* **245**: 272–278.
- Bonnefoy, N., F. Chalvet, P. Hamel, P. P. Slonimski and G. Dujardin, 1994a *OXA1* a *Saccharomyces cerevisiae* nuclear gene, whose sequence is conserved in prokaryotes and eukaryotes, controls cytochrome *c* oxidase biogenesis. *J. Mol. Biol.* **239**: 201–212.
- Bonnefoy, N., M. Kermorgant, O. Groudinsky, M. Minet, P. P. Slonimski *et al.*, 1994b Cloning of a novel human gene involved in cytochrome oxidase assembly by functional complementation of an *oxa1*-mutation in *Saccharomyces cerevisiae*. *Proc. Natl. Acad. Sci. USA* **91**: 11978–11982.
- Brasseur, G., J. Y. Coppee, A. M. Colson and P. Brivet-Chevillet, 1995 Structure-function relationships of the mitochondrial *bc1* complex in temperature-sensitive mutants of the cytochrome *b* gene, impaired in the catalytic center N. *J. Biol. Chem.* **270**: 29356–29364.
- Bruel, C., R. Brasseur and B. L. Trumpower, 1996 Subunit 8 of the *Saccharomyces cerevisiae* cytochrome *bc1* complex interacts with succinate-ubiquinone reductase complex. *J. Bioenerg. Biomembr.* **28**: 59–68.
- Dujardin, G., P. Pajot, O. Groudinsky and P. P. Slonimski, 1980 Long range control circuits within mitochondria and between nucleus and mitochondria. I. Methodology and phenomenology of suppressors. *Mol. Gen. Genet.* **179**: 469–482.
- Dutta, C., and H. L. Henry, 1990 Detection of hemoprotein peroxidase activity on polyvinylidene difluoride membrane. *Anal. Biochem.* **184**: 96–99.
- Grivell, L. A., 1995 Nucleo-mitochondrial interactions in mitochondrial gene expression. *Crit. Rev. Biochem. Mol. Biol.* **30**: 121–164.
- Hamel, P., W. Sakamoto, H. Wintz and G. Dujardin, 1997 Functional complementation of an *oxa1*-yeast mutation identifies an *Arabidopsis thaliana* cDNA involved in the assembly of respiratory complexes. *Plant J.* **12**: 101–109.
- Hase, T., M. Harabayashi, K. Kawai and H. Matsubara, 1987a Expression of modified cytochrome *c1* genes and restoration of the respiratory function in a yeast mutant lacking the nuclear cytochrome *c1* gene. *J. Biochem.* **102**: 401–410.
- Hase, T., M. Harabayashi, K. Kawai and H. Matsubara, 1987b A carboxyl-terminal hydrophobic region of yeast cytochrome *c1* is necessary for functional assembly into complex III of the respiratory chain. *J. Biochem.* **102**: 411–419.
- He, S., and T. D. Fox, 1997 Membrane translocation of mitochondrially coded Cox2p: distinct requirements for export of N and C termini and dependence on the conserved protein Oxa1p. *Mol. Biol. Cell* **8**: 1449–1460.
- Hell, K., J. Herrman, E. Pratje, W. Neupert and R. A. Stuart, 1997 Oxa1p mediates the export of the N- and C-termini of pCoxII from the mitochondrial matrix to the intermembrane space. *FEBS Lett.* **418**: 367–370.
- Hell, K., J. Herrman, E. Pratje, W. Neupert and R. A. Stuart, 1998 Oxa1p, an essential component of the N-tail export machinery in mitochondria. *Proc. Natl. Acad. Sci. USA* **95**: 2250–2255.
- Herrmann, J. M., W. Neupert and R. A. Stuart, 1997 Insertion into the mitochondrial inner membrane of a polytopic protein, the nuclear-encoded Oxa1p. *EMBO J.* **16**: 2217–2226.
- Kermorgant, M., N. Bonnefoy and G. Dujardin, 1997 Oxa1p, which is required for cytochrome *c* oxidase and ATP synthase complex formation, is embedded in the mitochondrial inner membrane. *Curr. Genet.* **31**: 302–307.
- Konishi, K., S. R. Van Doren, D. M. Kramer, A. R. Crofts *et al.*, 1991 Preparation and characterization of the water-soluble heme-binding domain of cytochrome *c1* from *Rhodospira sphaeroides* *bc1* complex. *J. Biol. Chem.* **266**: 14270–14276.
- Li, Y., K. Leonard and H. Weiss, 1981 Membrane-bound and water-soluble cytochrome *c1* from *Neurospora crassa*. *Eur. J. Biochem.* **116**: 199–205.
- Meyer, W., M. Bauer and E. Pratje, 1997a A mutation in cytochrome oxidase subunit 2 restores respiration of the mutant *pet1402*. *Curr. Genet.* **31**: 401–407.
- Meyer, W., U. Bomer and E. Pratje, 1997b Mitochondrial inner membrane bound PET1402 protein is rapidly imported into mitochondria and affects the integrity of the cytochrome oxidase and ubiquinol-cytochrome *c* oxidoreductase complexes. *Biol. Chem.* **378**: 1373–1379.
- Nakai, M., H. Ishiwatari, A. Asada, M. Bogaki, K. Kawai *et al.*, 1990 Replacement of putative axial ligands of heme iron in yeast cytochrome *c1* by site-directed mutagenesis. *J. Biochem.* **108**: 798–803.
- Pajot, P., M. Wambier-Kluppel, Z. Kotylak and P. Slonimski, 1976 Regulation of cytochrome oxidase formation by mutations in a mitochondrial gene for cytochrome *b*, pp. 443–451 in *Genetics and Biogenesis of Chloroplasts and Mitochondria*. Elsevier, North Holland Biomedical Press, Amsterdam.
- Pearce, D. A., and F. Sherman, 1995a Diminished degradation of yeast cytochrome *c* by interactions with its physiological partners. *Proc. Natl. Acad. Sci. USA* **92**: 3735–3739.
- Pearce, D. A., and F. Sherman, 1995b Degradation of cytochrome oxidase subunits in mutants of yeast lacking cytochrome *c* and suppression of the degradation by mutation of *yme1*. *J. Biol. Chem.* **270**: 20879–20882.
- Pullman, M., H. Penefsky, A. Datta and E. Racker, 1960 Partial resolution of the enzyme catalyzing oxidative phosphorylation. I. Purification and properties of soluble, dinitrophenol-stimulated adenosine triphosphatase. *J. Biol. Chem.* **235**: 3322–3329.
- Qiu, Z. H., L. Yu and C. A. Yu, 1992 Spin-label electron paramagnetic resonance and differential scanning calorimetry studies of the interactions between mitochondrial cytochrome *c* oxidase and adenosine triphosphate synthase complex. *Biochemistry* **31**: 3297–3302.
- Rep, M., J. Nooy, E. Guelin and L. A. Grivell, 1996a Three genes for mitochondrial proteins suppress null-mutations in both *Afg3* and *Rca1* when over-expressed. *Curr. Genet.* **30**: 206–211.
- Rep, M., and L. A. Grivell, 1996b The role of protein degradation in mitochondrial function and biogenesis. *Curr. Genet.* **30**: 367–381.
- Sadler, I., S. Kitaru, G. Schatz, F. Kaudewitz and A. Haid, 1984 Sequencing of the nuclear gene for the yeast cytochrome *c1* precursor reveals an unusually complex amino terminal sequence. *EMBO J.* **3**: 2137–2143.
- Suzuki, C. K., M. Rep, J. Maarteen Van Dijn, K. Suda, L. A. Grivell *et al.*, 1997 ATP-dependent proteases that also chaperone protein biogenesis. *Trends Biochem. Sci.* **22**: 118–123.
- Thorness, P. E., K. H. White and T. D. Fox, 1993 Inactivation of *YME1*, a member of the *ftsH-SEC18-PAS1-CDC48* family of putative ATPase-encoding genes, causes increased escape of DNA from mitochondria in *Saccharomyces cerevisiae*. *Mol. Cell. Biol.* **13**: 5418–5426.
- Trumpower, B. L., 1990 Cytochrome *bc1* complexes of microorganisms. *Microbiol. Rev.* **54**: 101–129.
- Tzagoloff, A., J. Yue, J. Jang and M.-F. Paul, 1994 A new member of a family of ATPase is essential for assembly of mitochondrial respiratory chain and ATP synthetase complexes in *Saccharomyces cerevisiae*. *J. Biol. Chem.* **269**: 26144–26151.
- Vargas, C., A. G. McEwan and J. A. Downie, 1993 Detection of c-type cytochromes using enhanced chemiluminescence. *Anal. Biochem.* **209**: 323–326.

Weilguny, D., M. Praetorius, A. Carr, R. Egel and O. Nielsen, 1991 New vectors in fission yeast: application for cloning the *his2* gene. *Gene* **99**: 47-54.

Xia, D., C. A. Yu, H. Kim, J. Z. Xia, A. M. Kachurin *et al.*, 1997 Crystal structure of the cytochrome *bc1* complex from bovine heart mitochondria. *Science* **277**: 60-66.

Zhang, Z., L. Huang, V. M. Shulmeister, Y. Chi, K. K. Kim *et al.*, 1998 Electron transfer by domain movement in cytochrome *bc1*. *Nature* **392**: 677-684.

Communicating editor: K. J. Newton